



DUET™



for the way you worship

SAUIDER®
— WORSHIP SEATING

DUET™

Many congregations prefer traditional seating styles for their synagogue, while maintaining the warmth that only wood can provide. With these unique demands, Sauder Manufacturing has added Duet™ to its line of seating. Our product brings together the tradition of the classic wooden frame with the comfort and accessibility of a current design.

This model is based on the elegant simplicity, quiet operation, and unique comfort of our Clarity line of auditorium seating. To meet both modern standards and historic expectations, flip-up seats are encased in the wooden framework of a traditional pew. Each seat quietly and consistently returns to its raised position, even after years of use. Our design also allows for increased spacing between rows.

With Duet, Sauder offers a wide collection of styles and preferences. Our product is available in maple, oak, or cherry wood species and all of our standard finishes. You can select from your choice of seat widths, fabric colors, ends, wooden or cushioned pew backs, and much more. The seats can also be purchased with our continuous bookrack. With our many options, you can choose sanctuary seating that corresponds with the needs of your worship facilities.

You'll also benefit from our professional project management system and no-hassle delivery and installation. From beginning to end, Duet demonstrates the craftsmanship and reliability that make Sauder Manufacturing the leader in worship furnishings.



Body 301-1168, End 301-4509 with custom symbol



Body 301-1168, End 302-1290



Body 301-1168, End 302-4750

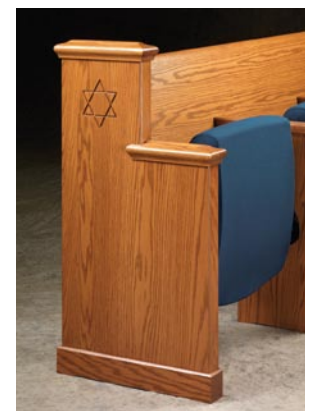

Body 301-4068, End 301-1316 with custom symbol

For more information on our wide selection of ends available for Duet™, or our full line of chairs, Bema furniture, fabrics and customized sanctuary furniture, visit our website at www.sauderworship.com

ACCESSORY



Our generous continuous bookrack contains a 3-3/4" D x 7-1/2" H pocket for use in storing your prayer books and other study materials

#308-0145 Continuous Bookrack

BODY STYLES



Body 301-6268



Body 301-4068

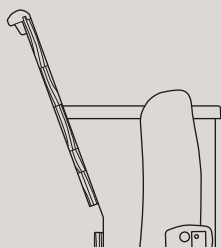

301-1168
straight solid wood
back

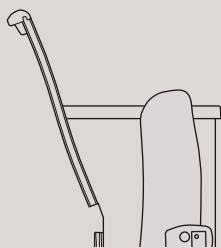

301-4068
contoured with wood
vener front & back

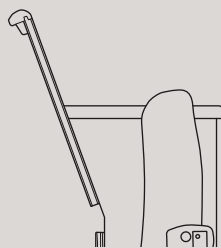

301-4168
straight with wood
vener front & back

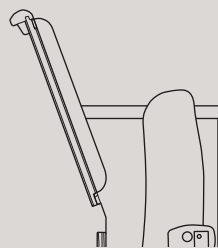

301-6268
straight, cushioned
back with wood
vener back of back

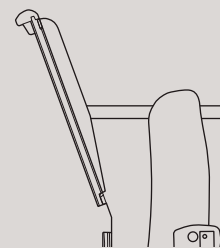

301-6768
straight, ergonomic
cushioned back with
wood veneer back of back

DIMENSIONS

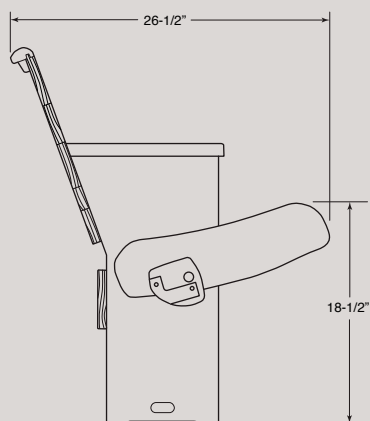
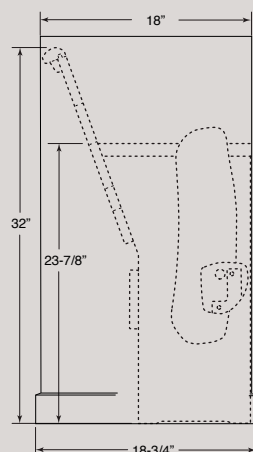

SEAT WIDTH OPTIONS

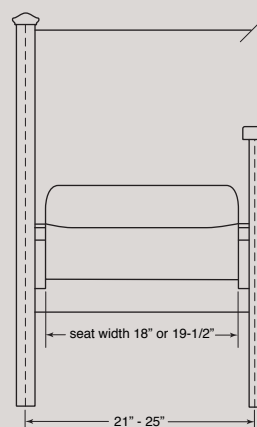

Standard Seat
18" standard seat with
21 - 23 1/2" spacing
center to center

Wide Seat
19 1/2" wide seat with
22 1/2" - 23 1/2" spacing
center to center

Wide Space
19 1/2" wide seat with
wider 24" - 25" spacing
center to center

*At Sauder, we've been helping communities of every faith
achieve their visions of worshipful interiors for more than 70 years.*

*We've worked closely with designers, architects, committees,
and clergy, listening to their hopes, their wishes,
their dreams and their concerns.*

*And we have responded, building a legacy of which
we, as a company, are very proud.*

*Today, there are more than twenty-five thousand
congregations worshipping on Sauder seating.*

*That so many congregations have trusted us,
referred us to friends, family, and associates, and have returned
to us as customers again and again, that fact more than any other,
testifies to the value of the principles of stewardship
and service that all of us at Sauder Manufacturing
work hard to live up to every day.*

Sauder Manufacturing Co.

930 W. Barre Road
Archbold, Ohio 43502-0230

Phone: 419-446-9384
Fax: 419-446-3697
Toll Free: 800-537-1530
(Canada and USA)

E-mail Address:
sales@sauderworship.com

SAUDER[®]
————— WORSHIP SEATING

www.sauderworship.com